



YASKAWA

YASKAWA AC Drive-Option Card

Analog Input Installation Manual

Type AI-A3

To properly use the product, read this manual thoroughly and retain for easy reference, inspection, and maintenance. Ensure the end user receives this manual.

安川インバータ オプションカード アナログ入力 取扱説明書

形式 AI-A3

製品を安全にお使い頂くために、この取扱説明書を必ずお読みください。
また、本書をお手元に保管していただくとともに、最終的に本製品をご使用になるユーザー様のお手元に確実に届けられるよう、お取り計らい願います。

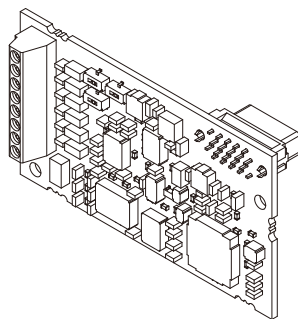

This Page Intentionally Blank



Table of Contents

1 PREFACE	4
2 PRODUCT OVERVIEW	7
3 OPTION CARD COMPONENTS	8
4 ELECTRICAL INSTALLATION	9
5 RELATED PARAMETERS	16
6 TROUBLESHOOTING	19
7 SPECIFICATIONS & WARRANTY INFORMATION	21

Copyright © 2008 YASKAWA ELECTRIC CORPORATION

All rights reserved. No part of this publication may be reproduced, stored in a retrieval system, or transmitted, in any form or by any means, mechanical, electronic, photocopying, recording, or otherwise, without the prior written permission of Yaskawa. No patent liability is assumed with respect to the use of the information contained herein. Moreover, because Yaskawa is constantly striving to improve its high-quality products, the information contained in this manual is subject to change without notice. Every precaution has been taken in the preparation of this manual.

Yaskawa assumes no responsibility for errors or omissions. Neither is any liability assumed for damages resulting from the use of the information contained in this publication.

1 Preface

Yaskawa manufactures products used as components in a wide variety of industrial systems and equipment. The selection and application of Yaskawa products remain the responsibility of the equipment manufacturer or end user. Yaskawa accepts no responsibility for the way its products are incorporated into the final system design. Under no circumstances should any Yaskawa product be incorporated into any product or design as the exclusive or sole safety control. Without exception, all controls should be designed to detect faults dynamically and fail safely under all circumstances. All systems or equipment designed to incorporate a product manufactured by Yaskawa must be supplied to the end user with appropriate warnings and instructions as to the safe use and operation of that part. Any warnings provided by Yaskawa must be promptly provided to the end user. Yaskawa offers an express warranty only as to the quality of its products in conforming to standards and specifications published in the Yaskawa manual. **NO OTHER WARRANTY, EXPRESS OR IMPLIED, IS OFFERED.** Yaskawa assumes no liability for any personal injury, property damage, losses, or claims arising from misapplication of its products.

◆ Applicable Documentation

This instruction manual has been written for the items listed below. Use this option card for its intended purpose only.

Option Card

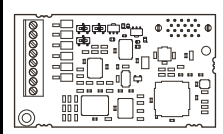
	<p>YASKAWA AC Drive-Option Card Analog Input AI-A3 Installation Manual (this book) Document No. TOBP C730600 38</p> <p>Read this manual first. It contains information required to install the option card and set up related drive parameters.</p>
----------------------------------------------------------------------------------	--------------------------------------------------------------------------------------------------------------------------------------------------------------------------------------------------------------------------------------------------------------------------------------

Drive

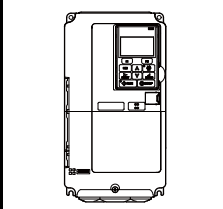
	<p>Refer to the manual of the drive this option card is being used with. The manual for the drive covers basic installation, wiring, operation procedures, functions, troubleshooting, and maintenance information. It also includes important information on parameter settings and how to tune the drive. To obtain instruction manuals for Yaskawa products access these sites: Europe: http://www.yaskawa.eu.com Japan: http://www.e-mechatronics.com Other areas: contact a Yaskawa representative.</p>
-----------------------------------------------------------------------------------	-----------------------------------------------------------------------------------------------------------------------------------------------------------------------------------------------------------------------------------------------------------------------------------------------------------------------------------------------------------------------------------------------------------------------------------------------------------------------------------------------------------------------------------------------------------------------------------------------------------------------------------

◆ Registered Trademarks

- Company names and product names listed in this manual are the registered trademarks of those companies.

◆ Supplemental Safety Information

Read and understand this manual before installing, operating or servicing this option unit.

The option unit must be installed according to this manual and local codes.

The following conventions are used to indicate safety messages in this manual. Failure to heed these messages could result in serious or possibly even fatal injury or damage to the products or to related equipment and systems.

DANGER

Indicates a hazardous situation, which, if not avoided, will result in death or serious injury.

WARNING

Indicates a hazardous situation, which, if not avoided, could result in death or serious injury.

CAUTION

Indicates a hazardous situation, which, if not avoided, could result in minor or moderate injury.

NOTICE

Indicates an equipment damage message.

1 Preface

■ General Safety

General Precautions

- The diagrams in this section may include option units and drives without covers or safety shields to illustrate details. Be sure to reinstall covers or shields before operating any devices. The option board should be used according to the instructions described in this manual.
- Any illustrations, photographs, or examples used in this manual are provided as examples only and may not apply to all products to which this manual is applicable.
- The products and specifications described in this manual or the content and presentation of the manual may be changed without notice to improve the product and/or the manual.
- When ordering a new copy of the manual due to damage or loss, contact your Yaskawa representative or the nearest Yaskawa sales office and provide the manual number shown on the front cover.

DANGER

Heed the safety messages in this manual.

Failure to comply will result in death or serious injury.

The operating company is responsible for any injuries or equipment damage resulting from failure to heed the warnings in this manual.

NOTICE

Do not expose the drive to halogen group disinfectants.

Failure to comply may cause damage to the electrical components in the option unit

Do not pack the drive in wooden materials that have been fumigated or sterilized.

Do not sterilize the entire package after the product is packed.

2 Product Overview



◆ Regarding this Product

Installing this option card to the drive allows the user to input a high resolution analog signal to the drive. The option card terminals can be set up in two ways.

- Separate functions for each terminal: Use the multi-function analog input terminals on the option card instead the drive's analog input terminals for a higher resolution signal.
- Combined input: The drive adds all signals input to the option card terminals to build the frequency reference.

◆ Checking Package Contents

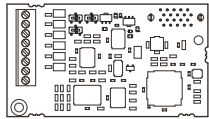
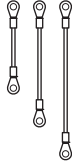
Table 1 Items Included with this Option Card

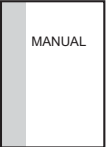
Package Contents	Option Card	Lead Lines (for grounding)	Screws (M3)	Manual (this book)
—				
Number of Items	1	3	3	1

- Inspect the Option Card for damage. If the Option Card appears damaged upon receipt, contact the shipper immediately.
- Verify receipt of the correct model by checking the model number printed on the Name plate of the Option Card. (see [Figure 1](#))
- If you have received the wrong model or the Option Card does not function properly, contact your supplier.

◆ Tools Required for Installation

A Phillips screwdriver PH1 (#1) is needed to install this option card.

Additionally a straight-edge screwdriver (blade depth: 0.4 mm, width: 2.5 mm) will be needed to wire the terminal block.

Note: Other tools are required for preparing cable connections.

3 Option Card Components

◆ Option Card

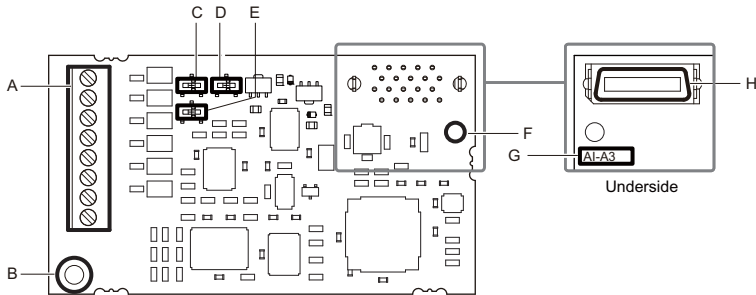

- | | |
|----------------------------------------------------------------------------|----------------------------------------------------------------------------|
| A – Terminal block TB1 | E – DIP switch S3 for terminal V3 input signal selection (voltage/current) |
| B – Ground Terminal (installation hole) | F – Model number |
| C – DIP switch S1 for terminal V1 input signal selection (voltage/current) | G – Installation hole |
| D – DIP switch S2 for terminal V2 input signal selection (voltage/current) | H – Connector (CN-5) |

Figure 1 Option Card

◆ Terminal Block

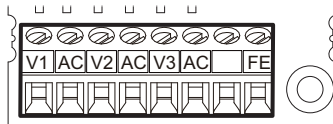

Figure 2 Terminal Block

4 Electrical Installation

◆ Safety Messages

DANGER

Electric Shock Hazard

Power to the drive must be shut off when installing this option card. Even though the power has been shut off, voltage still remains in the drive's DC bus. Wait before removing the front cover once the drive has been turned off. The CHARGE light on the drive will go out after voltage in the DC bus drops below 50 V, at which point it is safe to remove the front cover. Due to the risk of electric shock, be sure that all LEDs have gone out and that the DC bus voltage has reached a safe level prior to performing any work on the drive.

WARNING

Electrical Shock Hazard

Do not allow unqualified personnel to perform work on the drive. Failure to comply could result in death or serious injury. Maintenance, inspection, and replacement of parts must be performed only by authorized personnel familiar with installation, adjustment and maintenance of AC drives and Option Cards.

NOTICE

Damage to Equipment

Observe proper electrostatic discharge procedures (ESD) when handling the option unit, drive, and circuit boards.

Failure to comply may result in ESD damage to circuitry.

Never shut the power off while the drive is outputting voltage.

Failure to comply may cause the application to operate incorrectly or damage the drive.

Do not operate damaged equipment.

Failure to comply may cause further damage to the equipment.

Do not connect or operate any equipment with visible damage or missing parts.

Properly connect all pins and connectors.

Failure to comply may prevent proper operation and possibly damage equipment.

◆ Installing the Option Card

Insert the option card in the CN5-A connectors located on the drive's control board. See the drive manual for directions on removing the front cover.

1. Shut off power to the drive, wait the appropriate amount of time for voltage to dissipate, then remove the operator and front cover.
2. Insert the CN5 connector on the option card into the matching CN5 connector on the drive, then fasten it into place using one of the screws included with the option card.

Connect one of the lead lines using one of the screws to the ground terminal.

Note: There are only two screw holes on the drive for ground terminals. If three option cards are connected, two of the lead lines will need to share the same ground terminal.

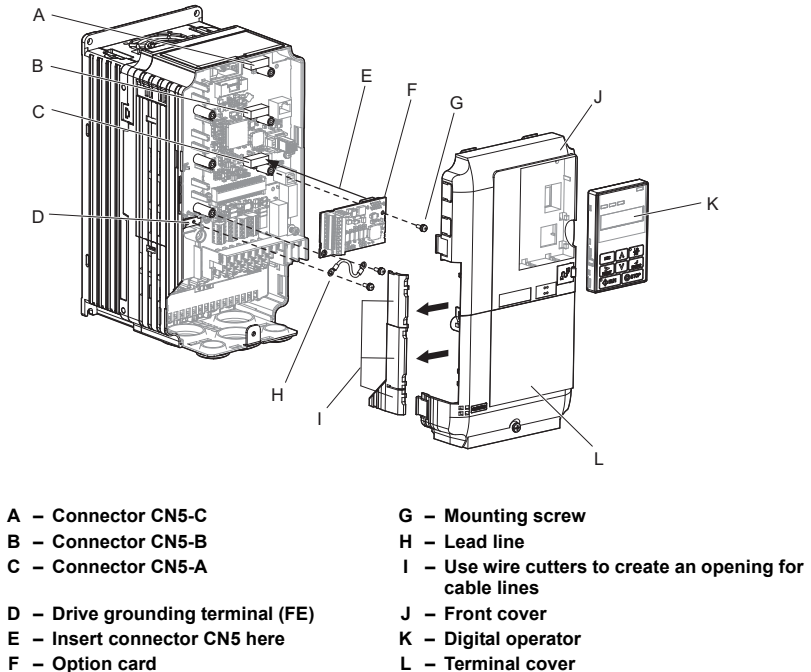

Figure 3 Installing the Option Card

4 Electrical Installation

3. Wire the option card to the terminal block on the option card.

For wiring instructions, see [Connection Diagram on page 13](#).

In the drives CIMR-A□2A0004 to 0040, 4A0002 to 0023 the cable might need to be routed through the top cover to the outside. In this case cut out the perforated openings at the left side of the drive top cover. Make sure no sharp edges that can damage the cable remain.

In the drives CIMR-A□2A0056 to 0211, 4A0031 to 0165 the cable can be routed inside the drive.

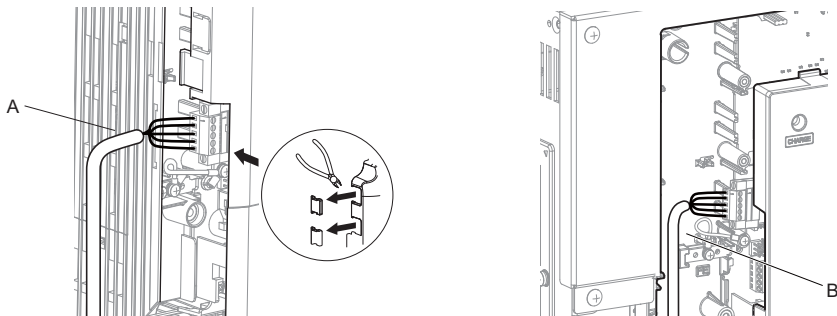

A – Wires should pass through the access hold provided on the left side of the front cover.
(CIMR-A□2A0004 to 0040, 4A0002 to 0023)

B – Use the open space provided inside the drive to route option card wiring.
(CIMR-A□2A0056 to 0211, 4A0031 to 0165)

Figure 4 Wiring space

4. Place the front cover back onto the drive.

- Note:**
1. Take care when wiring the option card so that the front cover easily fits back onto the drive. Make sure a cable is not caught between the front cover and the drive when putting the cover back on.
 2. The drive will not be used as NEMA Type1 if there is any exposed wiring outside the enclosure.

◆ Connection Diagram

Refer to *Figure 5* when wiring the terminal block on the option card.

Refer to *Terminal Functions on page 14* for information on terminals and S1 to S3.

To ensure accurate control, use stable power supply for the voltage reference source.

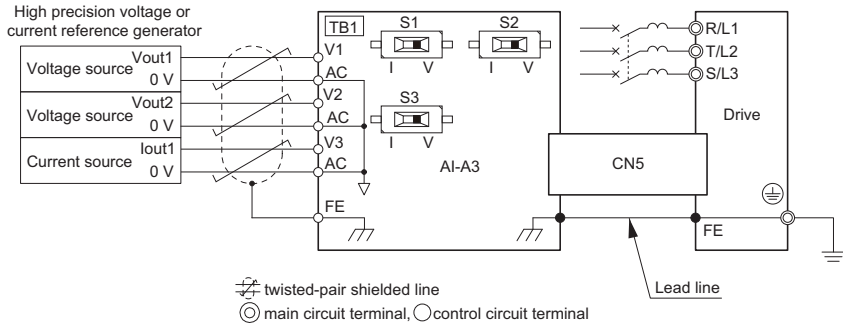

Figure 5 Wiring the Option Card and Drive

Take the following steps to prevent erroneous operation caused by noise interference:

- Use shielded wire for the signal lines.
- Keep wiring under 10 m.
- Make sure that control lines to the option card, main circuit wiring, and power lines are separated from one another.

■ Interface Circuit

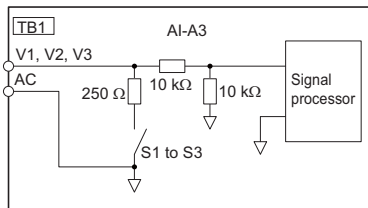

Figure 6 Interface Circuit

4 Electrical Installation

◆ Terminal Functions

Table 2 Terminal Functions

Terminal	Terminal Function	Signal Level	Description	Voltage/Current DIP switch	Linear Accuracy
V1	Analog signal input 1	-10 to 10 V or 4 to 20 mA	<ul style="list-style-type: none"> Input terminals for an analog voltage or current signal from voltage/current reference source. Use jumpers S1, S2, S3 to select the type of input signal. </> 	S1	±0.1% F.S. <>
V2	Analog signal input 2			S2	
V3	Analog signal input 3			S3	
AC	Common	–	Common for analog voltage/current input	–	
FE	Ground	–	Ground shielded lines here	–	–

<1> Default setting is for voltage input.

<2> At an ambient temperature of 25°C.

◆ Wire Gauges and Tightening Torque

Wire gauge specifications are listed below in [Table 3](#).

Yaskawa recommends using crimp terminals for easy of wiring and to ensure proper connection. Crimp terminal specifications can be found in [Table 4](#).

Table 3 Wire Gauges and Tightening Torque

Terminal signal	Screw Size	Tightening Torque (N·m)	Bare Cable		Wiring Gauges with Crimp Terminals		Wire Type
			Possible Gauges mm ² (AWG)	Recommended Gauges mm ² (AWG)	Possible Gauges mm ² (AWG)	Recommended Gauges mm ² (AWG)	
V1, V2, V3, AC, FE	M2	0.22 to 0.25	Stranded wire: 0.25 to 1.0 (24 to 17) Single line: 0.25 to 1.5 (24 to 16)	0.75 (18)	0.25 to 0.5 (24 to 20)	0.5 (20)	Shielded twisted pair, etc.

■ Crimp Terminals

Yaskawa recommends using CRIMPFOX ZA-3 by Phoenix Contact to crimp the terminal ends.

Note: Wire ends should be properly trimmed so no wire extends out from the crimp terminals.

Table 4 Crimp Terminal Sizes

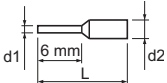
	Wire Gauge mm ² (AWG)	Model	L (mm)	d1 (mm)	d2 (mm)	Manufacturer
	0.25 (24)	AI 0.25 - 6YE	10.5	0.8	2	Phoenix Contact
	0.34 (22)	AI 0.34 - 6TQ	10.5	0.8	2	
	0.5 (20)	AI 0.5 - 6WH	14	1.1	2.5	

◆ Wiring Procedure

When wiring the option card, wire ends should be prepared as shown in [Figure 7](#). Refer to [Wire Gauges and Tightening Torque on page 14](#) and make sure not to exceed the maximum tightening torque.

Take particular precautions to ensure that each cable is properly connected, and that wire insulation has not been accidentally inserted into the terminals.

NOTICE: Insulation or tape may be required to ensure that shielded lines do not come into contact with other wiring. Insufficient insulation may cause a short circuit that can damage the option card and the drive.

NOTICE: Follow the tightening torque specifications in this manual for all terminal screws. Failing to do so may keep the drive from functioning properly and could damage the terminal block.

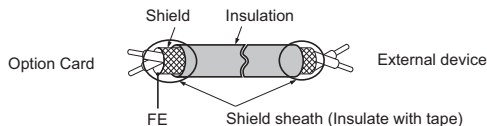

Figure 7 Treating Terminal Ends for Shielded Line

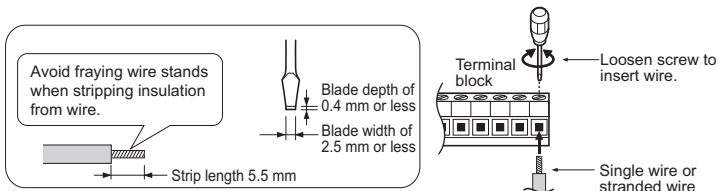

Figure 8 Terminal Block Wiring

5 Related Parameters

The following parameters are used to set up the drive for operation with an option card. Set parameters as needed. Instructions on how to set parameters can be found in the instruction manual for the drive the option card is connected to.

Table 5 Related Parameters

No.	Parameter Name	Description	Setting Range	Default
F2-01	Analog Input Option Card Operation Selection	0: Separate input channel 1: Combine input terminal values to create the frequency reference When F2-01 = 0, Frequency Reference Selection 1(b1-01) must be assigned to 1 (Analog input terminals).	0, 1	0
F2-02	Option Card Input Terminal Gain	Sets the gain for the analog reference as a percentage of the maximum output frequency.	-999.9 to 999.9	100.0%
F2-03	Option Card Input Terminal Bias	Sets the bias for the analog reference as a percentage of the maximum output frequency.	-999.9 to 999.9	0.0%
H3-02	Terminal A1 Function Selection	Sets the function of terminal A1.	0 to 31	0
H3-03	Terminal A1 Gain Setting	Sets the level of the input value selected in H3-02 when 10 V is input at terminal A1.	-999.9 to 999.9	100.0%
H3-04	Terminal A1 Bias Setting	Sets the level of the input value selected in H3-02 when 0 V is input at terminal A1.	-999.9 to 999.9	0.0%
H3-06	Terminal A3 Function Selection	Sets the function of terminal A3.	0 to 31	2
H3-07	Terminal A3 Gain Setting	Sets the level of the input value selected in H3-02 when 10 V is input at terminal A3.	-999.9 to 999.9	100.0%
H3-08	Terminal A3 Bias Setting	Sets the function of terminal A3.	-999.9 to 999.9	0.0%
H3-10	Terminal A2 Function Selection	Sets the function of terminal A2.	0 to 31	0
H3-11	Terminal A2 Gain Setting	Sets the level of the input value selected in H3-02 when 10 V is input at terminal A2.	-999.9 to 999.9	100.0%
H3-12	Terminal A2 Bias Setting	Sets the function of terminal A2.	-999.9 to 999.9	0.0%

No.	Parameter Name	Description	Analog Output Level	Unit
U1-21	Terminal V1 Input Voltage Monitor	Displays the voltage input level to terminal V1 on the analog option card AI-A3.	-10 to 10 V: -100 to 100% 4 to 20 mA: 0 to 100%	0.1%
U1-22	Terminal V2 Input Voltage Monitor	Displays the voltage input level to terminal V2 on the analog option card AI-A3.		0.1%
U1-23	Terminal V3 Input Voltage Monitor	Displays the voltage input level to terminal V3 on the analog option card AI-A3.		0.1%

◆ Setting Option Card Input Functions

■ Separate input channels (F2-01 = 0)

With this setting the terminals V1, V2, and V3 on the option card replace the drive analog inputs A1, A2, and A3 with higher resolution signals. The function, gain, and bias are set up in the same way as for the A1, A2, and A3 inputs using the H3-□□ parameters. For further details on setting these parameter, refer to the drive technical manual.

- Note:**
1. When the setting F2-01 = 0 is used the option card can not be selected as frequency reference source. Setting b1-01 = 3 while F2-01 = 0 will result in an oPE05 error.
 2. The drive automatically detects the selected signal level for each input. Parameters H3-01, H3-05, or H3-09 do not need to be set up. Their settings are disregarded.

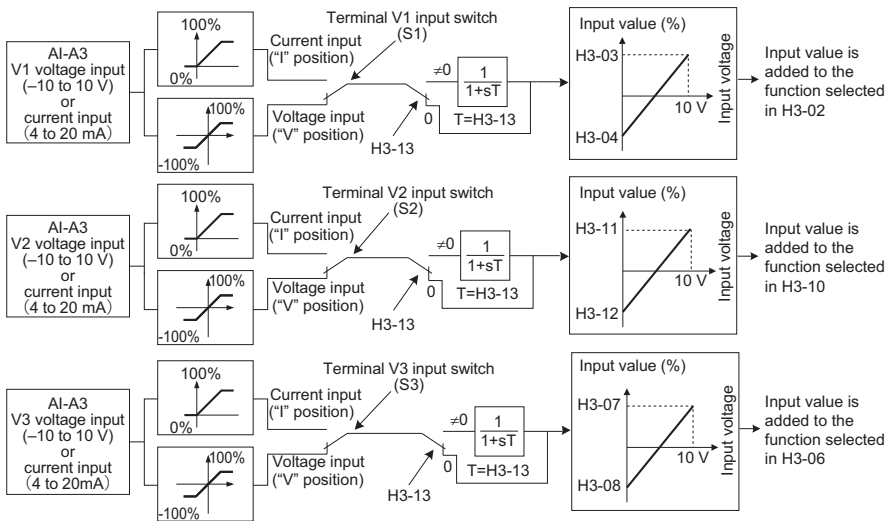

Figure 9 Using the Option Card for Multi-Function Analog Inputs

5 Related Parameters

■ Combined Inputs (F2-01 = 1)

With this setting the three input signals of the AI-A3 option card are combined to one frequency reference signal like illustrated in figure 10. Parameter b1-01 must be set to 3 to used this function. Gain and bias settings for the combined input signal can be set using parameters F2-02 and F2-03.

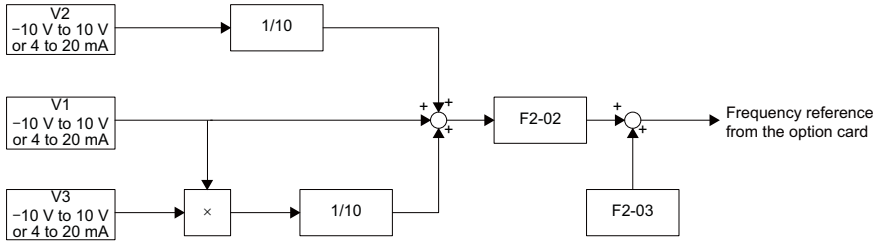

Figure 10 Combining Inputs for the Frequency Reference

■ Adjusting Input Levels

The gain set up in parameter F2-02 determines the percentage of the maximum output frequency that will be used as the frequency reference when the combined input signal is equal to 100% plus the bias set in F2-03 (for a single channel a voltage input of 10 V or a current input of 20 mA is referred as 100%).

The bias set up in parameter F2-03 determines the percentage of the maximum output frequency that will be used as the frequency reference when the combined input signal is 0% (for a single channel a voltage input of 0 V or a current input of 4 mA is referred as 0%).

Example 1: If the gain is set to 50% and the bias is 0%, then a combined input signal of 100% yields a frequency reference that is 50% of the maximum frequency reference. A combined input of 200% will yield a frequency reference equal to the maximum output frequency.

Example 2: If the gain is set to 200% and the bias is 0%, then a combined input signal of 50% yields a frequency reference equal to the maximum output frequency. In this case increasing the input signal will not lead to a higher reference as maximum frequency reference is already reached.

Example 3: If the bias is set to 30% while the gain is set to 100% a 0% combined signal yields a frequency reference of 30% of the maximum output frequency. Inputting a combined reference of 70% will yield a reference of equal to the maximum output frequency. As in example 2, a further increase of the combined signal will not increase the frequency reference.

6 Troubleshooting

◆ Error Codes Displayed on the Drive Operator



The table below lists the various fault codes related to this option card. Further detail on various faults can be found in the instruction manual for the drive.

- Check all cables connected to the option card.
- Make sure the option card is properly installed to the drive.

Table 6 Fault Display

Digital Operator Display		Fault Name
oFA01	oFA01	Option Card Connection Error at CN5-A
Cause		Possible Solution
Option card at port CN5-A was changed during run.		Switch the power off and reconnect the option card.
Digital Operator Display		Fault Name
oFb01	oFb01	Option Card Connection Error at CN5-B
Cause		Possible Solution
Option card at port CN5-B was changed during run.		Switch the power off and reconnect the option card.
Digital Operator Display		Fault Name
oFb02	oFb02	Duplicate Option at Port CN-B
Cause		Possible Solution
Same type of option card connected to ports CN5-A and CN5-B.		Use only compatible option cards. See note </>.
Digital Operator Display		Fault Name
oFC01	oFC01	Option Card Connection Error at CN5-C
Cause		Possible Solution
Option card at port CN5-C was changed during run.		Switch the power off and reconnect the option card.

6 Troubleshooting

Digital Operator Display		Fault Name
	oFC02	Duplicate Option Connected
Cause		Possible Solution
Same type of option card connected to ports CN5-A, CN5-B, and CN5-C.		Use only compatible option cards. See note <1>.
Digital Operator Display		Fault Name
	oPE05	Run Command/Frequency Reference Source Selection Error
Cause		Possible Solutions
Frequency reference is assigned to an option card (b1-01 = 3) but an input option card is not connected to the drive.		Reconnect the input option card to the drive.
Digital Operator Display		Error Name
	oPE07	Multi-Function Analog Input Selection Error
Cause		Possible Solutions
At least two analog input terminals are set to the same function. Analog input terminal and Pulsetrain input are set to the same function.		Change the settings to H3-02, H3-06, and H3-10 so that functions no longer conflict.

<1> Depending on the type of option card, only a certain number of cards may be connected at the same time. Refer to table below. More details can be found in the option card section of the drive instruction manual.

Table 7 Option Card Installation

Option Card	Connector	Number of Cards Possible
SI-C3, SI-N3, SI-P3, SI-S3, AI-A3, DI-A3 <2>	CN5-A	1
PG-B3, PG-X3	CN5-B, C	2 <3>
DO-A3, AO-A3	CN5-A, B, C	1

<2> The AI-A3 and DI-A3 option can also be installed to option ports CN5-B and CN5-C, but are then used for monitoring purposes only. Input levels are then displayed in U1-17, U1-21 to U1-23. Here, the option cards cannot be used to set the frequency reference or replace the drive analog input with higher resolution inputs.

<3> If only one PG option card is connected to the drive, use the CN5-C connector. If two PG option cards are connected, use both CN5-B and CN5-C.

7 Specifications & Warranty Information

◆ Specifications

Table 8 Specifications

Model	AI-A3
Input Terminals	3 Terminals
Voltage Input	Input signal voltage: -10 to 10 Vdc Impedance: 20 k Ω Input resolution: 13 bit plus sign (1/8 192)
Current Input	Input signal voltage: 4 to 20 mA Impedance: 250 k Ω Input resolution: 12 bit (1/4096)
Linear Precision	$\pm 0.1\%$ at 25 °C
Ambient Temperature	-10 °C to 50 °C
Humidity	95%Rh or less with no condensation
Storage Temperature	-20 °C to 60 °C allowed for short-term transport of the product
Area of use	Indoor (free of corrosive gas, airborne, particles)
Altitude	1000 m or less

7 Specifications & Warranty Information

◆ Revision History

The revision dates and numbers of the revised manuals are given on the bottom of the back cover.

MANUAL NO. TOBP C730600 38A

Published in Japan July 2008 08-7

Date of
publication

Date of original
publication

Date of Publication	Rev. No	Section	Revised Content
July 2008	—	—	First edition

YASKAWA AC Drive-Option Card

Analog Input

Installation Manual

IRUMA BUSINESS CENTER (SOLUTION CENTER)

480, Kamifuji-sawa, Iruma, Saitama 358-8555, Japan
Phone 81-4-2962-5696 Fax 81-4-2962-6138

YASKAWA ELECTRIC AMERICA, INC.

2121 Norman Drive South, Waukegan, IL 60085, U.S.A.
Phone 1-847-887-7000 Fax 1-847-887-7370

YASKAWA ELÉTRICO DO BRASIL LTDA.

Avenida Fagundes Filho, 620 São Paulo-SP CEP 04304-000, Brazil
Phone 55-11-3585-1100 Fax 55-11-5581-8795

YASKAWA ELECTRIC EUROPE GmbH

Hauptstraße 185, 65760 Eschborn, Germany
Phone 49-6196-569-300 Fax 49-6196-569-398

YASKAWA ELECTRIC UK LTD.

1 Hunt Hill Orchardton Woods Cumbernauld, G68 9LF, United Kingdom
Phone 44-1236-735000 Fax 44-1236-458182

YASKAWA ELECTRIC KOREA CORPORATION

7F, Doore Bldg. 24, Yeoido-dong, Youngdungpo-Ku, Seoul 150-877, Korea
Phone 82-2-784-7844 Fax 82-2-784-8495

YASKAWA ELECTRIC (SINGAPORE) PTE. LTD.

151 Lorong Chuan, #04-01, New Tech Park 556741, Singapore
Phone 65-6282-3003 Fax 65-6289-3003

YASKAWA ELECTRIC (SHANGHAI) CO., LTD.

No.18 Xizang Zhong Road, Room 1702-1707, Harbour Ring Plaza Shanghai 200001, China
Phone 86-21-5385-2200 Fax 86-21-5385-3299

YASKAWA ELECTRIC (SHANGHAI) CO., LTD. BEIJING OFFICE

Room 1011A, Tower W3 Oriental Plaza, No.1 East Chang An Ave.,
Dong Cheng District, Beijing 100738, China
Phone 86-10-8518-4086 Fax 86-10-8518-4082

YASKAWA ELECTRIC TAIWAN CORPORATION

9F, 16, Nanking E. Rd., Sec. 3, Taipei, Taiwan
Phone 886-2-2502-5003 Fax 886-2-2505-1280



YASKAWA

YASKAWA ELECTRIC CORPORATION

In the event that the end user of this product is to be the military and said product is to be employed in any weapons systems or the manufacture thereof, the export will fall under the relevant regulations as stipulated in the Foreign Exchange and Foreign Trade Regulations. Therefore, be sure to follow all procedures and submit all relevant documentation according to any and all rules, regulations and laws that may apply. Specifications are subject to change without notice for ongoing product modifications and improvements.

© 2008 YASKAWA ELECTRIC CORPORATION. All rights reserved.

MANUAL NO. TOBP C730600 38A

Published in Japan July 2008 08-7
08-5-3